

# AIROSD

Main part suppliers and strategic cooperation partners



Panasonic

SIEMENS



+GF+

GRUNDFOS

wilo

CALEFFI

Complete service system



AIROSD Craftsman  
Professional concentration



AIROSD BIM  
Technology

The benefits of  
AIROSD  
service system

1. Reliability
2. Security
3. Energy saving
4. High performance
5. Long service life
6. Noise reduction

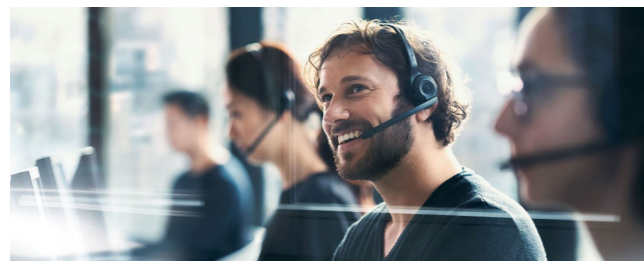

24h free service hotline  
365 days comfortable five-star  
service  
Hotline 400-900-5930  
Technical support center to follow  
up the whole process

Foshan Airosd Thermal Technology Co., Ltd.

ADD: Dongfeng Road, Songxia Industrail Park, Nanhai City,  
Guangdong Province of China

Tel:0757-85611840、81796616 Fax: 0757 - 81796613

Web : Http:www.airosd.com

Email :airosd@airosd.com

All rights reserved by Italian airosd Holding Group Co., Ltd



Subscription account service account

WWW.AIROSD.COM



Italian airosd Holding Group Co., Ltd.  
Foshan airosd Thermal Energy Technology Co., Ltd  
(Joint development)

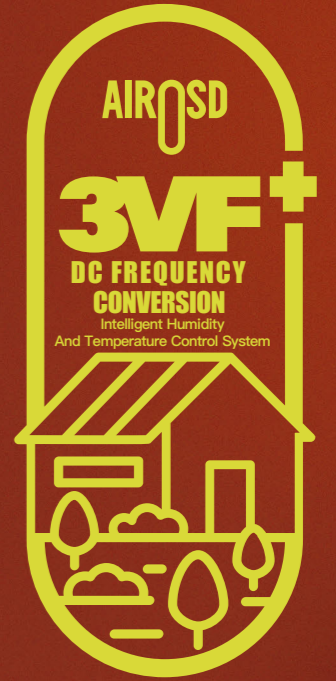

CHOICES FROM 76 COUNTRIES AROUND THE WORLD

# AIROSD





## AIROSD - NEW ERA OF HIGH SPEED HEAT PUMP

AIROSD has a world leading R&D laboratory and a team of senior engineers. In China, we are known as a technology master in the industry. With advanced technology, efficient cooperation and scientific manufacturing process, AiroSD plays an important role in the research, development, design and other aspects of DC inverter heat pump industry.

We have a number of national laboratories, such as “national -35°C ultra-low ambient temperature Calibration Laboratory” “Air Conditioner and Heat Pump Dryer Laboratory” “Long Time Reliability Operating Laboratory” “simulated vibration (stress) test bench”

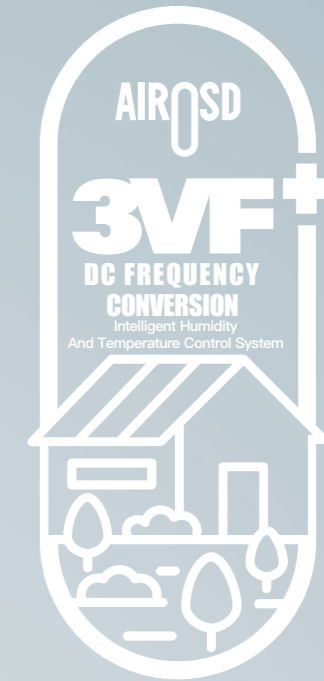

# OPEN A NEW ERA OF TEMPERATURE AND HUMIDITY INDEPENDENT CONTROL SYSTEM

Whether it is a villa or an apartment, whether it is residential or commercial, whether it is summer or winter, we all need appropriate temperature and humidity to live. AiroSD 3vf+ temperature & humidity independent control system can integrate all functions to meet the needs of consumers in the most scientific way, which is healthy, comfortable and energy-saving.



## Complete installation service system

Reliable materials, advanced tools, exquisite workmanship, comprehensive supervision and professional delivery



### 1 DC Inverter air source heat pump

3vf+ series DC inverter air source heat pump unit, equipped with DC inverter compressor, fan and stainless steel centrifugal water pump, is the best in energy saving. In terms of stability, DC inverter unit can still operate stably under  $-20^{\circ}\text{C}$  low ambient temperature.



COP value 4.6 ultra high energy efficiency  
 $\leq 52\text{dB (a)}$  ultra quiet design  
 $\pm 0.5^{\circ}\text{C}$  constant temperature energy management

Energy saving up to 70%

### 2 Ultra-thin silent indoor fan coil

The DC inverter fan of AiroSD can adjust the indoor environment at any time according to the working conditions. By intelligently and accurately adjusting the air volume and water flow, the indoor environment can be adjusted to the ideal comfort of the human body.

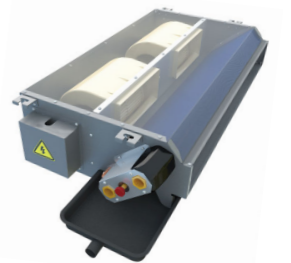

### 3 Double cold source central dehumidification fresh air system

Air handling unit integrating fresh air, filtration, purification, dehumidification and other functions



### 4 AI intelligent control system

AiroSD's eco smart system can easily control the equipment in every room of your home, which makes the whole system more energy-saving. We also developed intelligent control app to realize remote control equipment.





**AIRQSD**



### More comfortable water system

In summer, the traditional air conditioner can always remove the heat, but it also takes away the water vapor in the room, which will accelerate the loss of moisture on the surface of the skin, and the skin always feels dry.

**AIRQSD** Water system central air conditioner is cooler and more moist!



Water system constant temperature

Traditional floor heating is comfortable, but electricity is expensive

**AIRQSD** Water system central air conditioner is cooler and more moist!



## Constant oxygen and humidity Healthier

Do you feel uncomfortable in the wet and cold season? All this is the result of excessive moisture.

**AIRQSD**

Central dehumidification system protects family health!



## DC Frequency Conversion more energy efficient

AiroSD 3vf+ series DC inverter air source heat pump is equipped with DC inverter compressor, DC inverter fan coil, stainless steel multi-stage centrifugal water pump, multi-stage impeller and high head, which comprehensively improves the performance of the whole machine, with higher energy efficiency and lower noise.

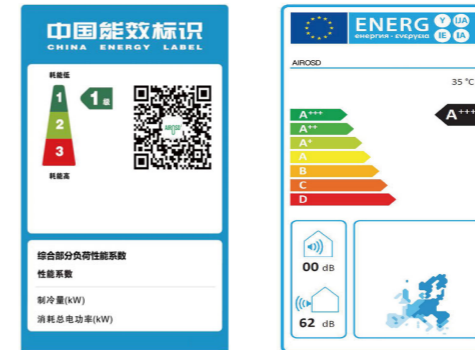

Two primary energy efficiency



### Comfortable cooling

The cooling temperature in summer is closer to the human body, cooling air outlet temperature is 14~17 degrees, and the "cool but not cold".



### Stable heating

Suitable cold and warm temperature, soft skin feeling. The stable heating technology and defrosting technology of airoSD DC inverter make the indoor temperature close to the human body temperature.

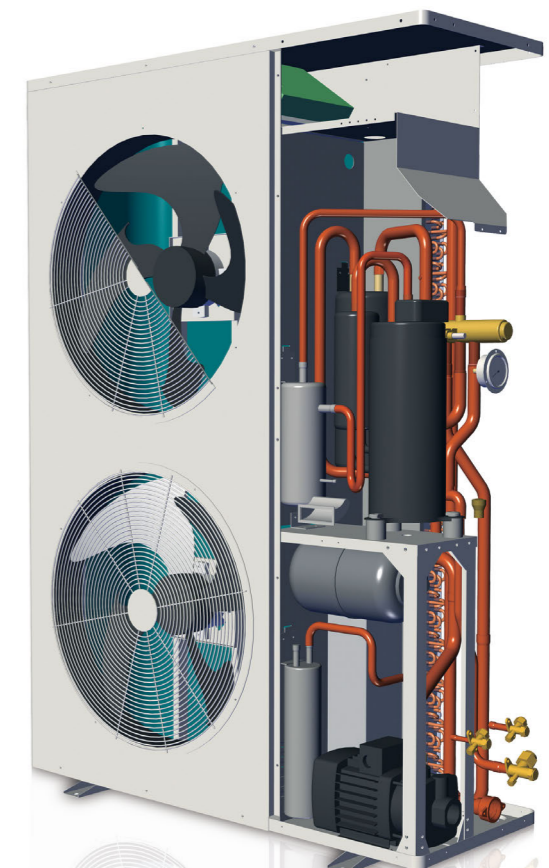

Warm in winter, cool in summer, constant temperature, constant humidity and constant oxygen provide a healthy and comfortable home for the family



*Intelligent Humidity  
And Temperature Control System*



COP value 4.6 ultra high energy efficiency  
≤ 52dB (a) ultra quiet design  
±0.5°C constant temperature energy management



Heating at -20°C  
ultra-low ambient  
temperature



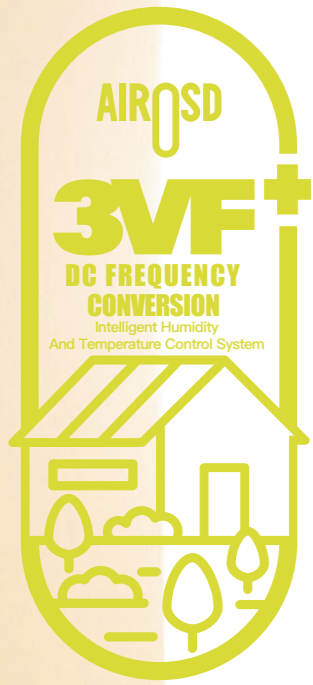

## Comfortable cooling

The temperature and humidity independent control system of airoSD 3vf+ series DC inverter can meet the requirements of higher quality and comfortable refrigeration. The air outlet temperature is 14 °C-17 °C, which is closer to the human body temperature. Compared with fluorine system air conditioning, it is not only more comfortable and energy-saving, but also can be centrally controlled and managed, and can be measured by layers and households. Small investment, simple and convenient maintenance and repair.

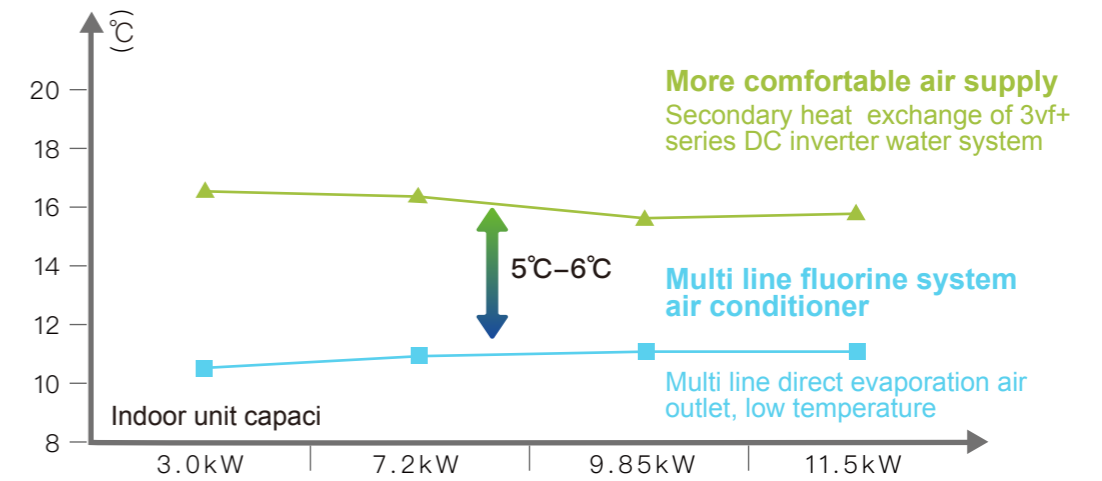

## Cooling and dehumidification system

The traditional "fluorine air conditioner" discharges water equivalent to 6 bottles of mineral water from the air every hour. Excessive dehumidification is easy to cause hoarseness of the voice, dryness of the skin and water shortage. AiroSD's 3vf+ series DC inverter water system air conditioner can control the temperature scientifically, balance the humidity, keep the appropriate temperature and humidity of the human body, and make the body and mind healthier.

Type	AiroSD 3vf+ series Fully direct rheologic frequency water system	Traditional "fluorine" air conditioner
Dehumidification	Dehumidification cool comfort	Excessive dehumidification
Dehumidification capacity	3 Bottles of mineral water	6 Bottles of mineral water
Moisture content		



## Fast defrost

The research shows that when the outdoor temperature is between 0°C~4°C, the outdoor unit of the air conditioner is very easy to frost. Under heating conditions, after heat exchange, the temperature of the fins is lower than the outdoor temperature, and the water vapor in the outside air will frost on the fins, which will affect the heating effect.

The control system of airosd defrosting technology will monitor the changes of outdoor ambient temperature and heat exchanger fin temperature in real time, so as to determine whether it is necessary to enter the defrosting mode. When the real-time monitored fin temperature reaches the predetermined value, the host system will automatically enter or exit the defrosting mode to avoid the phenomena of no defrosting or incomplete defrosting. Effectively improve defrosting efficiency and heating capacity. The defrosting time is reduced to less than 1-2 minutes to truly realize the no sensory defrosting and improve the user's comfort experience.

### Defrosting Technology No heat reduction and constant indoor temperature

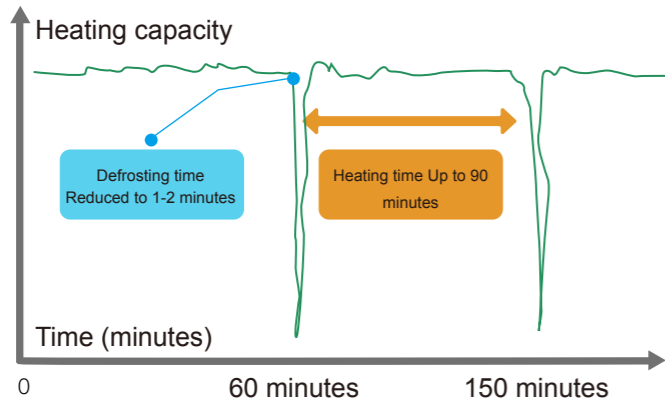

**Airosd heat pump defrosting curve**  
Defrosting technology with in 2 minutes and the super long heating time of 90 minutes effectively ensure that the indoor temperature is stable and comfortable.

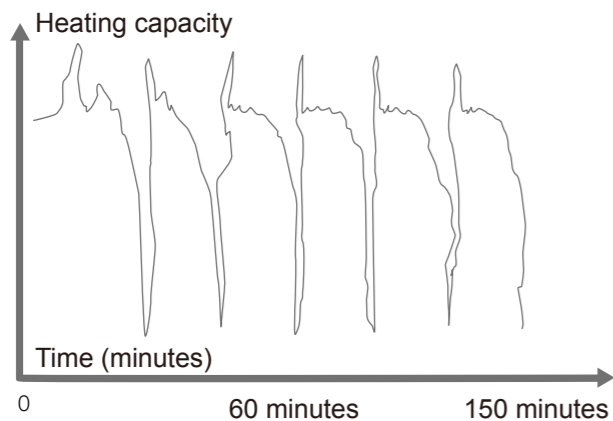

**Common heat pump defrosting curve**  
Frequent defrosting, ineffective defrosting and short heating time lead to the failure of indoor temperature rise, sudden cooling and sudden heating.

# AIROSD

## Intelligent Humidity And Temperature Control System

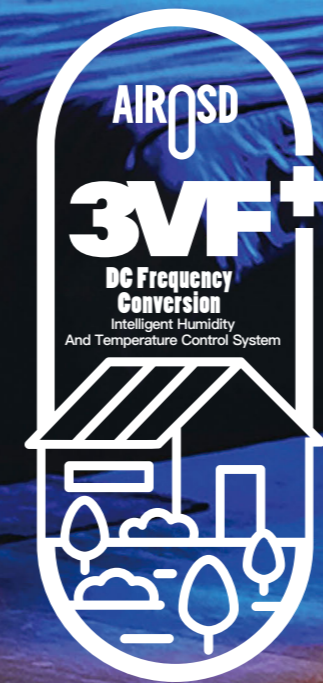



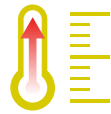

## Health preserving floor heating

"Keep your feet warm and your head cool" is the way of health maintenance advocated by traditional Chinese medicine, and floor heating is the ideal way of heating in winter. The way of floor radiation makes people feel warm and comfortable.

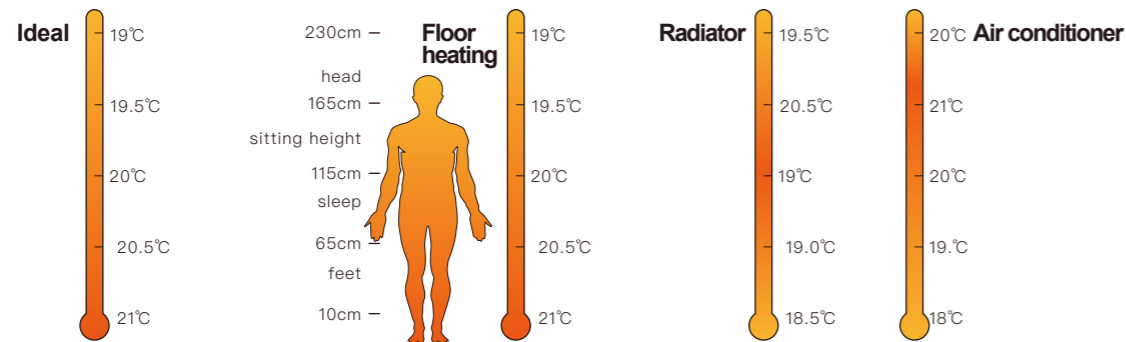

Floor radiant heating is more suitable for human physiological needs

Traditional air conditioning heating: large vertical temperature difference

The 3v+ full DC inverter system can realize the three in one of air conditioning, floor heating and fresh air dehumidification. Compared with traditional air conditioners, the system is more stable and the heating system is more powerful. In severe cold winter, the dual operation mode of floor heating and air conditioning can be adopted; Turn on the air conditioner for rapid heating, and then the floor heating will maintain the appropriate indoor temperature, and the heat will warm the body from the sole of the foot, perfectly integrating the traditional health preservation theory and modern human engineering science.

## Built in hydraulic module

The unit is equipped with water pump (optional), expansion tank, water flow switch, automatic pressure relief valve, automatic exhaust valve, etc. to keep the whole circulating system in balance at all times and make the system more stable.

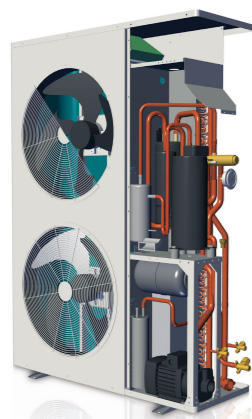

No attenuation due to tube length

At the end of indoor heat exchange, the medium is liquid water, so the air conditioning capacity will not be reduced due to the pipe length. Built in expansion tank and other hydraulic modules to ensure normal water system pressure.

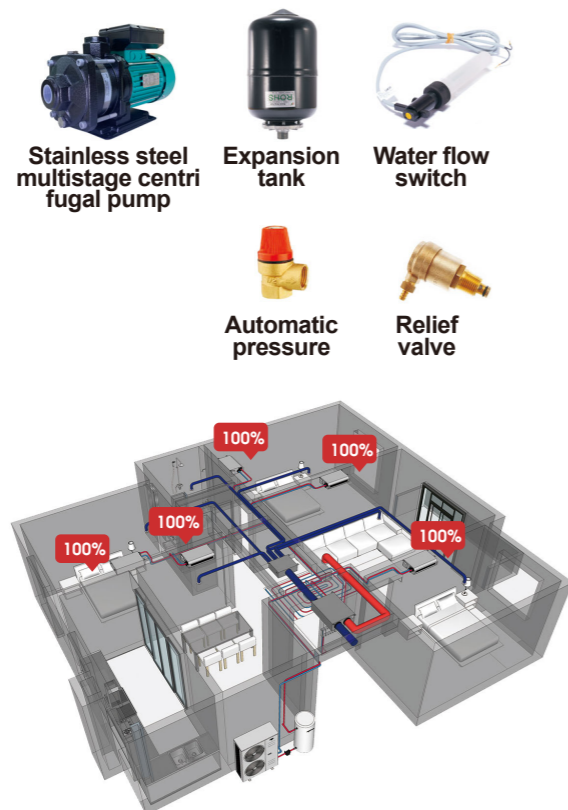

## High energy efficiency comes from core accessories

Large capacity double rotor DC inverter compressor  
Bi-directional back pressure technology, stable operation and small wear

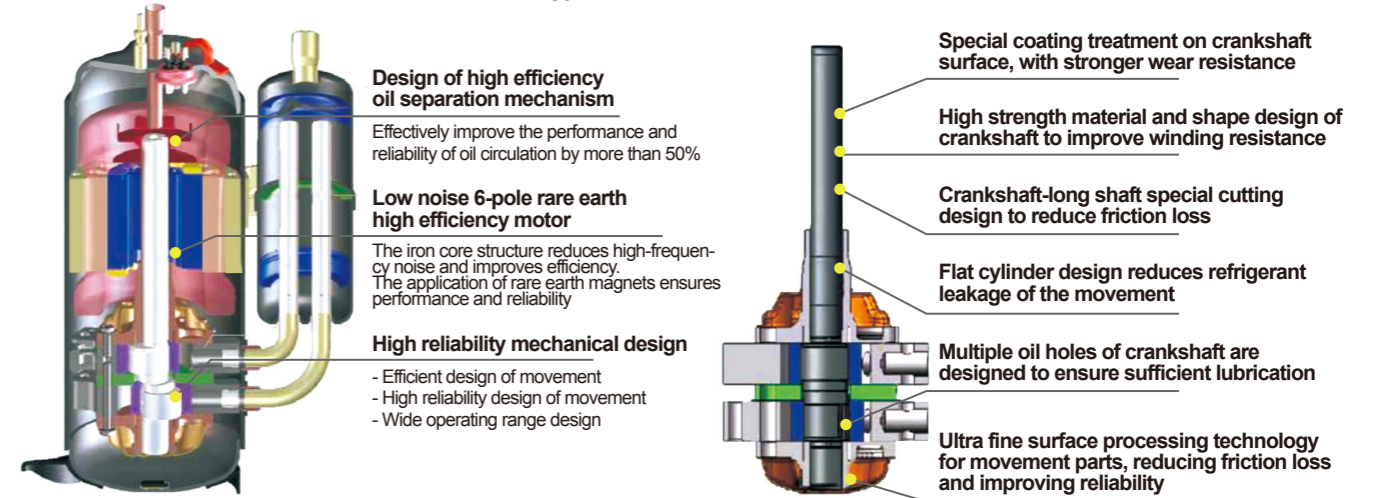

### Energy saving silent DC brushless fan motor

Significantly reduce energy consumption while improving wind pressure and motor durability



### High speed 32-bit MCU frequency converter

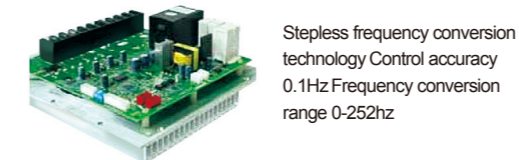

### Motor efficiency comparison

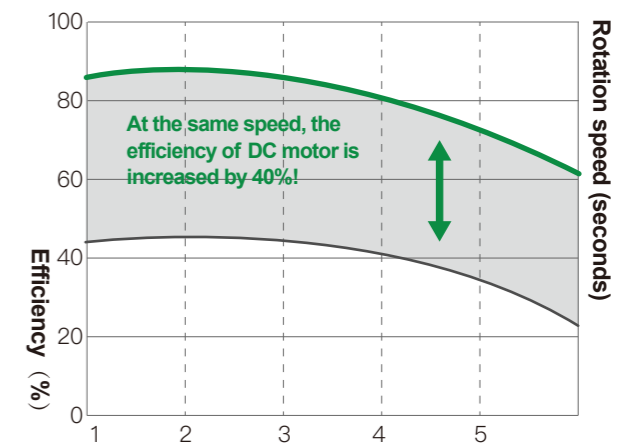

### High efficiency condenser

Design of hyperbolic sinusoidal heat exchanger with multiple rows of tubes and multiple loops, Higher heat exchange efficiency

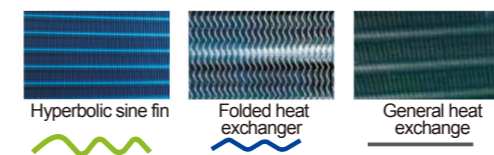

### TISO pipeline design greatly improves the heat exchange efficiency of refrigerant

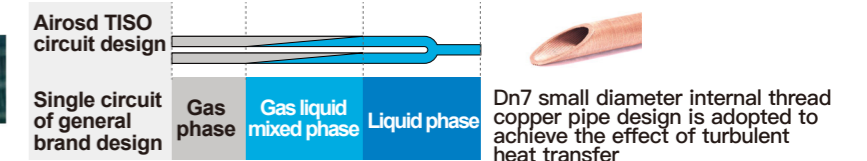

### High efficiency plate form heat exchanger of water side

Stainless steel brazed countercurrent plate heat exchanger adopts a new design to make the refrigerant flow distribution more uniform, effectively use the plate heat exchange area, provide evaporation temperature and reduce the freezing risk.

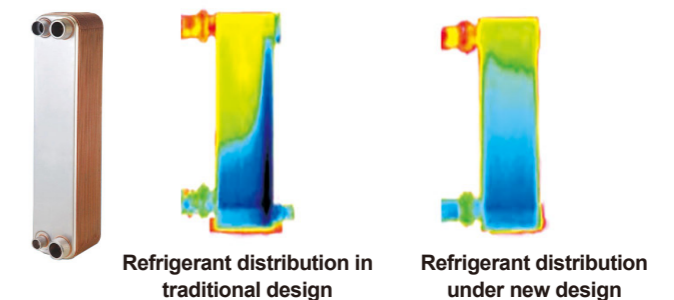



**Central air conditioning with floor heating and fresh air dehumidification**



**Create comfortable and healthy standards with 12 core technologies**

Airostd technology master has introduced new innovative achievements. We hope to bring comfort and satisfaction to your life through unremitting efforts in R & D innovation, lean production and star service.



**Multiple functions**

The unit can realize strong heating in winter, rapid cooling in summer and annual humidity regulation.



**DC inverter technology**

The new full DC inverter technology is adopted, can adjust the different frequencies according to the changes of ambient temperature and humidity, to achieve temperature and humidity comfort.



**Low noise design**

We realize sound insulation and noise reduction through 3D design technology, shock absorption technology and silencing system design.



**AI intelligent**

AI intelligent controller realizes the self balance of the system, including heating, cooling, intelligent defrosting and heat pump cascade.



**Health preserving**

"Keep your feet warm and your head cool" is the way of health maintenance advocated by traditional Chinese medicine, and floor heating is the ideal way of heating in winter.



**Operation at low temperature**

With full DC inverter compressor, the unit can operate stably at -20 with higher energy efficiency ratio.



**Fast defrost**

Unique evaporator design and intelligent defrosting algorithm make defrosting faster and more accurate.



**Cool dehumidification**

The system can scientifically control the balance between humidity and temperature, and avoid air drying caused by excessive dehumidification of traditional air conditioners.



**Anti secondary icing**

The water discharged due to heating and defrosting will freeze at the bottom. Airostd patented ice melting technology can melt the ice stored at the bottom.



**Comfortable cooling**

3v+ system design makes indoor air temperature and humidity more controllable, making people more comfortable and healthy.



**High efficiency and energy saving**

The energy efficiency exceeds the first level standard, ensuring the efficient operation of the heat pump and saving costs.



**ECO-friendly refrigerant**

R32 environment-friendly refrigerant is used. The refrigerant is placed in the outdoor unit. Even if it leaks, it will not pollute the indoor environment.

### Technical parameters of 3vf+ full DC inverter series

a: Cooling condition: DB 35°C , inlet water temperature 12°C , outlet water temperature 7°C ;

b: Heating conditions:DB / WB7°C/6°C, inlet water temperature 40°C, outlet water temperature 45°C;

Due to product improvement, above data are subject to change without prior notice, please take the nameplate on the heat pump as standard.

Model		QBKFJK-012SMI	QBKFJK-014SMI	QBKFJK-016SMI	QBKFJK-017SMI
		QBKFJK-012SMI/P	QBKFJK-014SMI/P	QBKFJK-016SMI/P	QBKFJK-017SMI/P
Photo					
Cooling	Cooling capacity (KW)	10.0	13.0	14.0	15.0
	Input power (KW)	3.23	4.19	4.19	4.89
	EER	3.10	3.1	3.34	3.07
	Running current (A)	15	19.1	19.1	22.3
Heating	Heating capacity (KW)	12	14	16	17
	Input power (KW)	3.33	4.24	4.24	5.15
	COP	3.6	3.3	3.8	3.3
	Running current (A)	15.3	19.3	19.3	23.4
Excluding water pump	Max. operating current (A)	22	30	30	32
	Max. input power (KW)	4.8	6.6	6.6	7
	Water side pressure loss (KPa)	≤25	≤30	≤30	≤35
Built in water pump	Input power (KW)	0.30	0.19	0.37	0.19
	External lift (m)	≥10	≥8	≥13	≥6
compressor	Form	DC inverter rotor	DC inverter rotor	DC inverter rotor	DC inverter rotor
	Brand	Mitsubishi	Panasonic	Panasonic	Panasonic
Power specifications (V/Hz)		220V/50Hz	220V/50Hz	220V/50Hz	220V~/50Hz
Application ambient temp. (°C)		-20~45	-20~45	-20~45	-20~45
IPLV (C)		4.32	4.35	4.38	4.32
Outlet water temp. range(°C)		5~58	5~58	5~58	5~58
Refrigerant type (-/kg)		R32/R410	R32/R410A	R32/R410A	R32/R410A
Airoutlet		Sideward	Sideward	Sideward	Sideward
No. of fans		1	1	2	1
Nozzle size		G1.0 Internal thread	G1.0 Internal thread	G1.0 Internal thread	G1.0 Internal thread
Max. working pressure of heat exchanger (MPa)		4.5	4.5	4.5	4.5
Max. working pressure of suction/discharge (MPa)		1.5/4.5	1.5/4.5	1.5/4.5	1.5/4.5
Max. working pressure at water side(MPa)		1	1	1	1
Waterproof grade		IPX4	IPX4	IPX4	IPX4
Anti electric shock type		class I	class I	class I	class I
Water flow (m³/h)		1.72	2.24	2.24	2.58
Volume of expansion tank(L)		5	/	5	/
noise (dB(A))		≤55	≤56	≤56	≤56
Dimension (w*d*h mm)		950×390×1000	1095×450×1000	950×390×1350	1095×450×1000
Net weight	Excluding water pump(kg)	85	110	120	110
	Including water pump(kg)	93	115	135	115

Model		QBKFJK-018SMI	QBKFJK-024SMII	QBKFJK-030SMII
		QBKFJK-018SMI/P	QBKFJK-024SMII/P	QBKFJK-030SMII/P
Photo				
Cooling	Cooling capacity (KW)	16.0	22.0	28.0
	Input power (KW)	5.05	6.78	9.49
	EER	3.17	3.24	2.95
	Running current (A)	23	11.0	17.4
Heating	Heating capacity (KW)	18	24.0	30
	Input power (KW)	5.45	6.95	8.70
	COP	3.30	3.45	3.45
	Running current (A)	24.8	12.0	15.5
Excluding water pump	Max. operating current (A)	32	18.7	25
	Max. input power (KW)	7.0	10.5	14.0
	Water side pressure loss (KPa)	≤35	≤35	≤35
Built in water pump	Input power (KW)	0.37	0.55	0.50
	External lift (m)	≥12	≥13	≥13
compressor	Form	DC inverter rotor	DC inverter rotor	DC inverter rotor
	Brand	Panasonic	Mitsubishi	Mitsubishi
Power specifications (V/Hz)		220V/50Hz	380V~3N/50Hz	380V~3N/50Hz
Application ambient temp. (°C)		-20~45	-20~45	-20~45
IPLV (C)		4.35	4.43	4.42
Outlet water temp. range(°C)		5~58	5~58	5~58
Refrigerant type (-/kg)		R32/R410A2.8	R32/R410A3.5	R32/R410A
Airoutlet		Sideward	Sideward	Sideward
No. of fans		2	2	2
Nozzle size		G1.0 Internal thread	G1.2 Internal thread	G1.2 Internal thread
Max. working pressure of heat exchanger (MPa)		4.5	4.5	4.5
Max. working pressure of suction/discharge (MPa)		1.5/4.5	1.5/4.5	1.5/4.5
Max. working pressure at water side(MPa)		1	1	1
Waterproof grade		IPX4	IPX4	IPX4
Anti electric shock type		class I	class I	class I
Water flow (m³/h)		2.67	3.44	4.82
Volume of expansion tank(L)		5	5	5
noise (dB(A))		≤56	≤59	≤62
Dimension (w*d*h mm)		950×390×1350	1095×400×1575	1095×400×1575
Net weight	Excluding water pump(kg)	120	150	225
	Including water pump(kg)	135	165	240

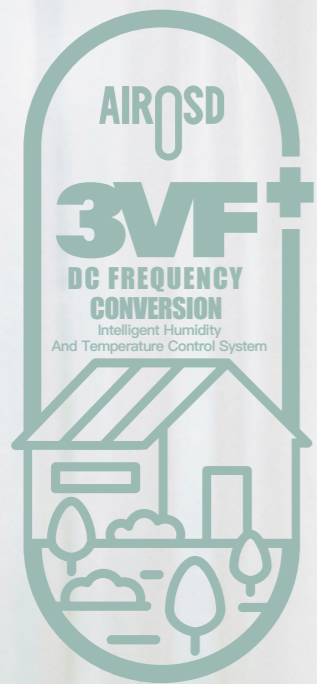

**Enjoy the family time.**  
Floor heating + dehumidification + central air conditioning solution



**Strong heating at -20°C for  
superior comfort**

### Parameter table

#### A200 series - DC quiet ultra-thin indoor unit

MODEL (A200)		FP-51WA-DC	FP-68WA-DC	FP-85WA-DC	FP-102WA-DC	FP-136WA-DC	FP-170WA-DC	
Rated airvolume	m³/h	510	680	850	1020	1300	1700	
Rated cooling	KW	3.40	4.00	5.20	6.10	7.60	9	
RATED HEATING 60°C	KW	5.40	6.30	7.90	9.10	12.50	13.50	
RATED HEATING 45°C	KW	3.65	4.30	5.25	6.20	7.90	8.80	
RATED INPUT POWER/12PA	H	W	18	28	30	45	69	
OPERATING CURRENT/12PA	H	A	0.16	0.26	0.29	0.43	0.65	
FCEER	W/W	159	125	136	105	109	93	
FCCOP (60°C)	W/W	253	198	206	157	180	148	
FCCOP (45°C)	W/W	171	135	137	107	114	96	
NOISE/12PA (THIRD GEAR)	L/M/H	dB(A)	18/23/34	20/28/39	23/30/38	24/31/42	24/32/42	24/33/44
NOISE/12PA (FIFTH GEAR)	1/2/3/4/5	dB(A)	18/21/23/29/34	20/24/28/34/39	23/26/30/34/38	24/27/31/36/42	24/28/32/37/42	24/28/33/38/44
DIMENSION	H*W*D	mm	200*1000*475	200*1000*475	200*1300*475	200*1300*475	200*1600*475	200*1600*475
SIZE OF AIR OULET	H*W	mm	110*990	110*990	110*1290	110*1290	110*1590	110*1590
SIZE OF AIR INLET	H*W	mm	200*990	200*990	200*1290	200*1290	200*1590	200*1590
EXTERNAL STATIC PRESSURE	Pa	12						
CONNECTING PIPING	INLET AND OUTLET PIPE	inch	DN20 ( INNER THREAD)					
	DRAIN-PIPE	inch	DN20 (EXTERNAL THREAD)					
WORKING PRESSURE AT WATER SIDE	MPa	1.6						
WATER FLOW	m³/h	0.6	0.7	0.9	1	1.2	1.5	
WATER DRAG	kPa	15	15	25	35	35	40	
NO. OF COPPER TUBE ROWS		3						
COIL TYPE		HIGH QUALITY COPPER TUBE WITH HYDROPHILIC ALUMINUM FIN						
CONDENSATE TRAY TYPE		INTEGRATED STAINLESS STEEL / 10MM RUBBER INSULATION						
FAN	FORM	PLASTIC CENTRIFUGAL FORWARD MULTI AIRFOIL						
	QUANTITY	2	2	3	3	4	4	
MOTOR TYPE	form	LOW NOISE, HIGH PRECISION BALL BEARING PERMANENT MAGNET SYNCHRONOUS MOTOR						
	quantity	1	1	1	1	1	1	
	POWER SUPPLY	220V~50Hz						
	PROTECTION CLASS	IP 42						
	INSULATION CLASS	Class B						
NET WEIGHT	Kg	23	23	29.5	29.5	36	36	

#### Remarks:

- Rated cooling capacity measurement conditions: indoor temperature db/wb 27 °C/19.5 °C, inlet water temperature 7 °C, outlet water temperature 12C; Rated heating capacity measurement conditions: indoor temperature DB 21 °C, inlet water temperature 60 °C.
- Rated air volume measurement condition: DB 20 °C standard air, coil is dry.
- The operation data recorded in this parameter table shall be measured in the anechoic room; During actual installation, it is generally higher than the recorded due to the influence of surrounding noise and reflected sound.
- During actual use, some parameters may change due to different environments; Please discuss with your local dealer or Airoad technician to develop a best system.
- The last character segment of the model only indicates the production batch. Airoad may adjust it without notice. Please refer to the nameplate of the actual product.

### Dimension outline drawing

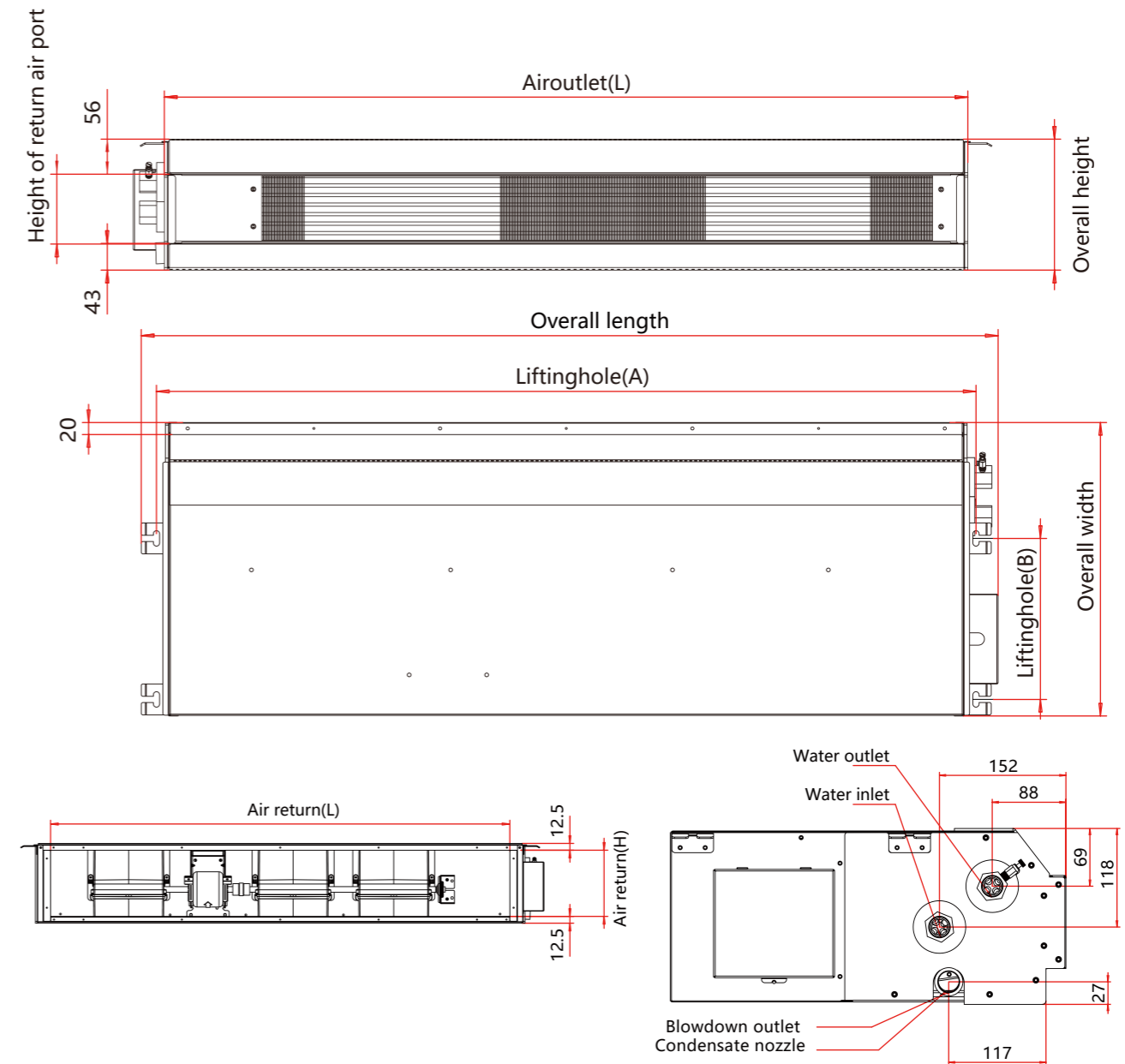

UNIT: MM

A200	LIFTINGHOLE(A)	LIFTINGHOLE(B)	AIROULET(L)	AIROULET(H)	AIR RETURN(L)	AIR RETURN(H)	OVERALL LENGTH	OVERALL WIDTH	OVERALL HEIGHT	FANS
FP-51/68WA	830	260	795	110	750	175	1000	475	200	2
FP-85/102WA	1130	260	1095	110	1050	175	1300	475	200	3
FP-136/170WA	1430	260	1395	110	1350	175	1600	475	200	4

## Parameter table

### A230 series AC silent indoor unit

model (A230)			FP-34W	FP-51WA	FP-68WA	FP-85WA	FP-102WA	FP-136WA	FP-170WA	FP-204WA	FP-238WA
Rated air volume	CMH	H/M/L	340/280/210	510/380/255	680/520/335	850/660/455	1020/825/560	1360/960/665	1700/1315/905	2040/1610/1160	2380/1630/1180
Rated cooling	KW	H/M/L	2.1/1.8/1.7	3/2.7/2.3	3.8/3.3/2.8	4.5/4/3.5	5.8/5.3/4.5	7.6/6.4/5.7	9/8/6.9	10.8/9.6/8.5	12.6/10.6/9.4
Rated heating 60°C	KW	H/M/L	3.5/3.1/2.6	5.2/4.4/3.6	6.7/5.8/4.6	7.9/6.7/5.5	10/8.7/7.1	13.5/10.9/9.1	16/13.6/11.2	19/16.3/13.4	21/17.6/14.3
FCEER			53	55	52	53	47	53	52	49	45
FCCOP60 °C			85	90	87	88	80	89	88	83	75
FCCOP45 °C			53	55	52	53	47	53	52	49	45
Rated input power (H/M/L)	W	12Pa	30/25/23	43/28/23	60/47/39	74/69/53	93/68/56	130/114/95	147/118/94	183/133/112	221/177/140
	W	30Pa	43/36/29	57/40/32	70/47/40	84/67/56	105/78/64	151/136/90	169/149/133	206/157/126	245/179/145
	W	50Pa	48/38/31	64/50/38	81/64/57	97/65/55	114/85/76	169/122/83	204/141/125	243/173/128	291/259/221
Noise (H/M/L)	dB(A)	12Pa	36/26/23	27/27/20	41/30/23	43/34/25	45/36/29	46/39/28	48/40/32	50/42/35	52/47/32
	dB(A)	30Pa	38/30/23	41/33/20	41/30/24	43/32/24	43/35/27	43/37/30	49/42/36	49/40/32	49/43/34
	dB(A)	50Pa	42/32/24	44/34/28	46/37/33	47/40/36	49/42/38	48/39/33	52/45/37	54/46/40	56/49/42
Dimension	mm	W*D*H	735*500*230	935*500*230	935*500*230	1150*500*230	1150*500*230	1455*500*230	1850*500*230	1850*500*230	2015*500*230
Size of air outlet	mm	W*D	485*140	685*140	685*140	905*140	905*140	1205*140	1600*140	1600*140	1770*140
Size of air inlet	mm	W*D	445*195	645*195	645*195	865*195	865*195	1165*195	1600*195	1600*195	1725*195
External static pressure	12/30/50Pa										
Connecting piping	Inlet and outlet pipe	DN20 (inner thread)									
	drain-pipe	DN20 (external thread)									
Working pressure at water side	1.6										
Water flow	l/s		6	8.9	10.9	12.9	16.6	21.8	25.8	31	36.1
Water drag	kPa		20	26	18	24	36	39	32	39	45
No. of copper tube rows	3										
Coil type	High quality copper tube with hydrophilic aluminum fin										
Condensate tray type	Galvanized sheet integrated forming / plastic spraying and painting antirust process / 10mm thick B1 rubber and plastic insulation										
Fan	form	ABS high strength plastic centrifugal forward multi airfoil									
	quantity		1	2	2	2	2	3	4	4	4
Motor type	form	Low noise, high precision ball bearing AC motor									
	quantity		1	1	1	1	1	2	2	2	2
	Power Supply	220V-50HZ									
	Protection	IP42									
Insulation class	Class B										
Net weight	Kg		14	16	16	20.5	20.5	25.5	31	31	33

#### Remarks:

- Rated cooling capacity measurement conditions: indoor temperature db/wb 27 °C/19.5 °C, inlet water temperature 7 °C, outlet water temperature 12C; Rated heating capacity measurement conditions: indoor temperature DB 21 °C, inlet water temperature 60 °C.
- Rated air volume measurement condition: DB 20 °C standard air, coil is dry.
- The operation data recorded in this parameter table shall be measured in the anechoic room; During actual installation, it is generally higher than the recorded due to the influence of surrounding noise and reflected sound.
- During actual use, some parameters may change due to different environments; Please discuss with your local dealer or Airoad technician to develop a best system.
- The last character segment of the model only indicates the production batch. Airoad may adjust it without notice. Please refer to the nameplate of the actual product.

## Dimension outline drawing

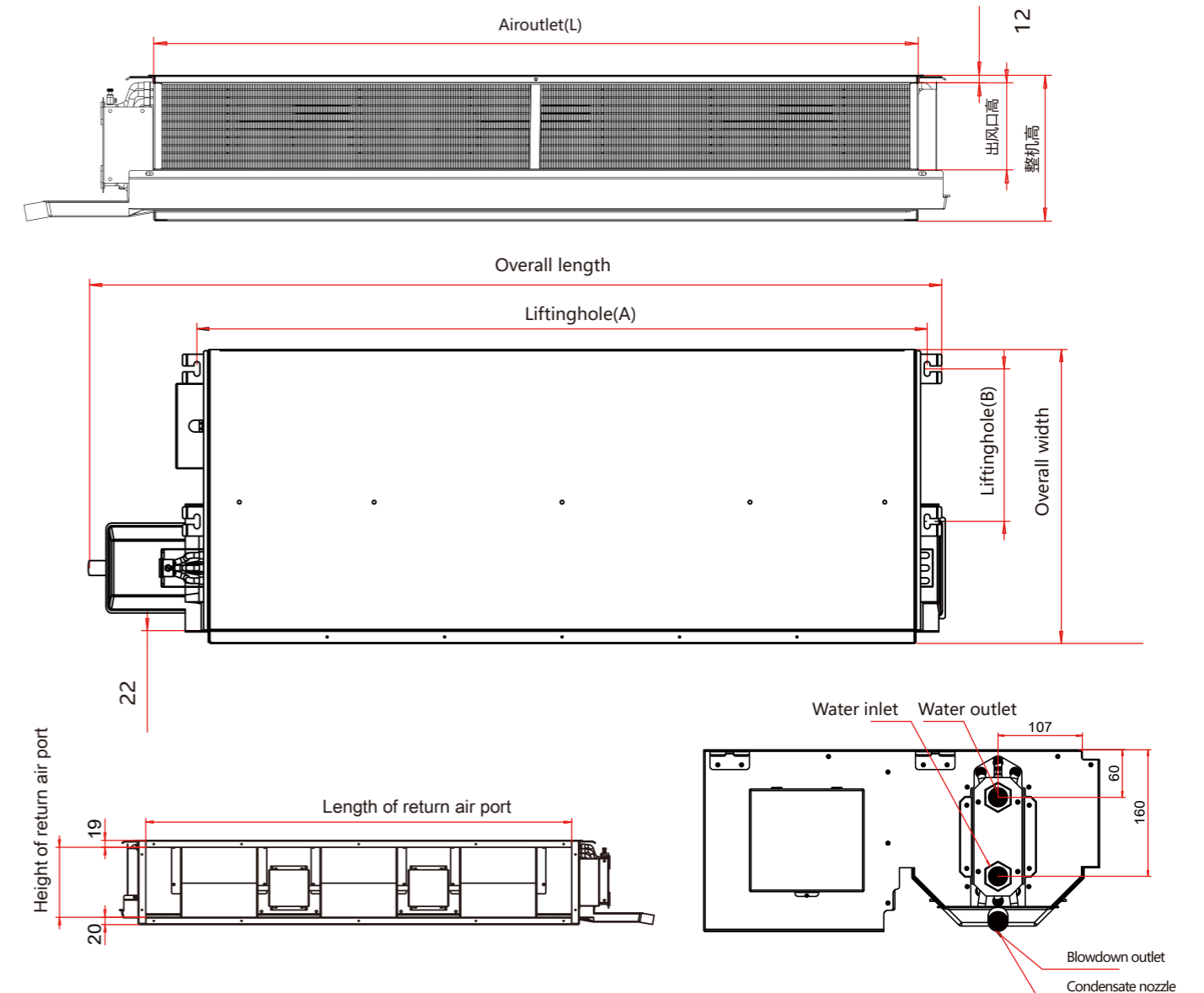

Unit : mm

A230	Liftinghole(A)	Liftinghole(B)	Airoutlet(L)	Airoutlet(H)	Air return(L)	Air return(H)	Overall length	Overall width	Overall height	Fans
FP-34WA	525	260	485	140	445	195	735	500	230	1
FP-51/68WA	725	260	685	140	645	195	935	500	230	2
FP-85/102WA	945	260	905	140	865	195	1150	500	230	2
FP-136WA	1245	260	1205	140	1165	195	1455	500	230	3
FP-170/204WA	1640	260	1600	140	1600	195	1850	500	230	4
FP-238WA	1805	260	1770	140	1725	195	2015	500	230	4

## Dimension outline drawing

QBKFXK-012SMI  
QBKFXK-012SMI/P

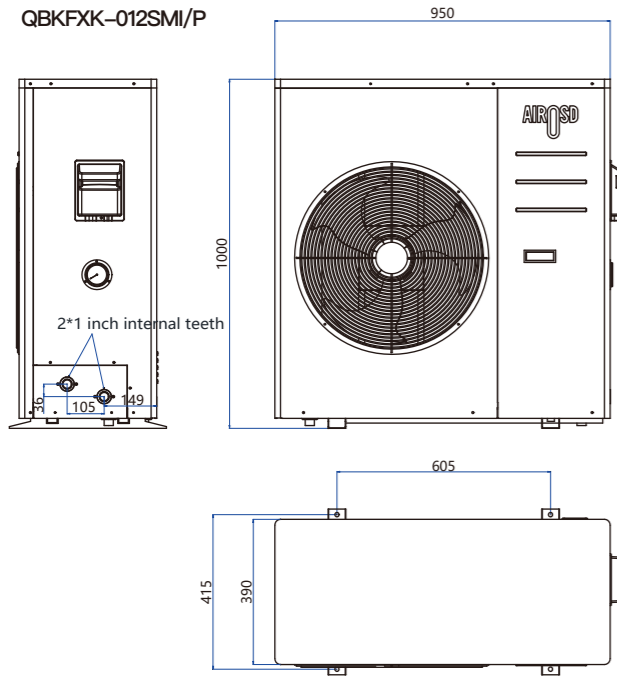

QBKFXK-014SMI  
QBKFXK-014SMI/P

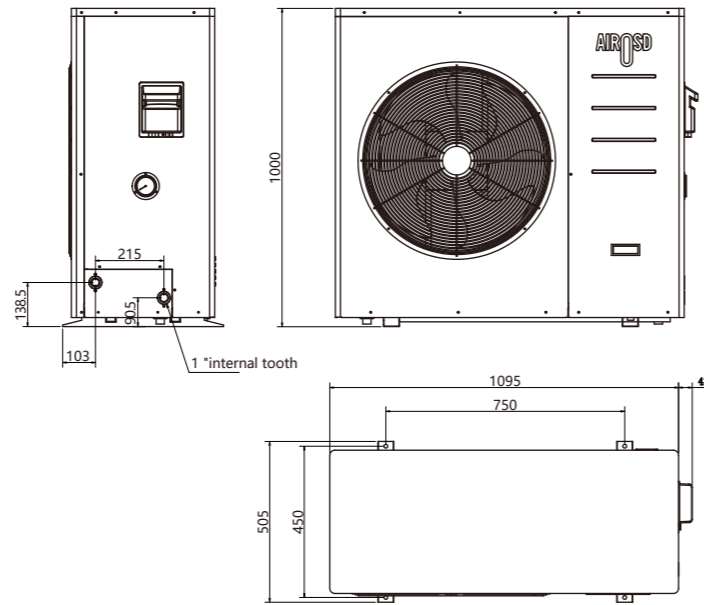

QBKFXK-016SMI  
QBKFXK-016SMI/P

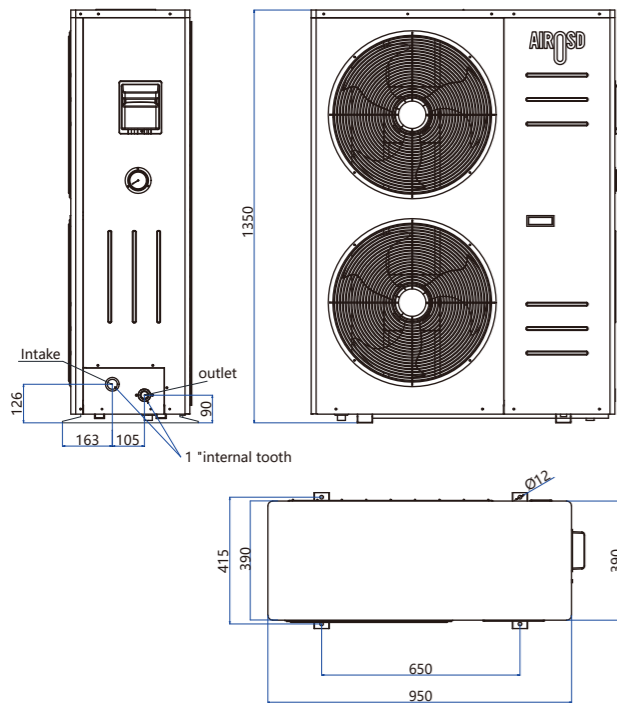

QBKFXK-024SMII  
QBKFXK-024SMII/P

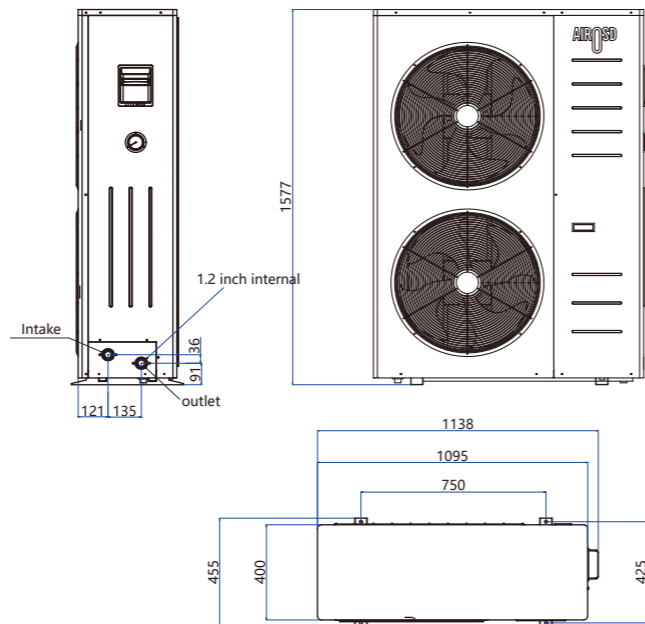

## Installation spacing diagram

1. The installation space of a single machine is shown in the following diagram (mm)

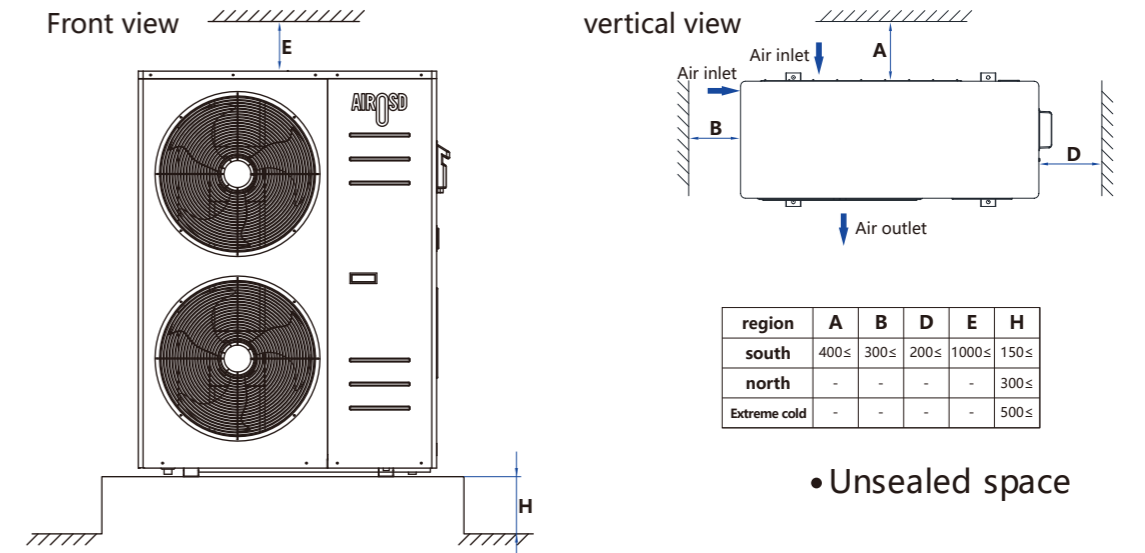

2. Installation space description of multiple units (unit: mm)

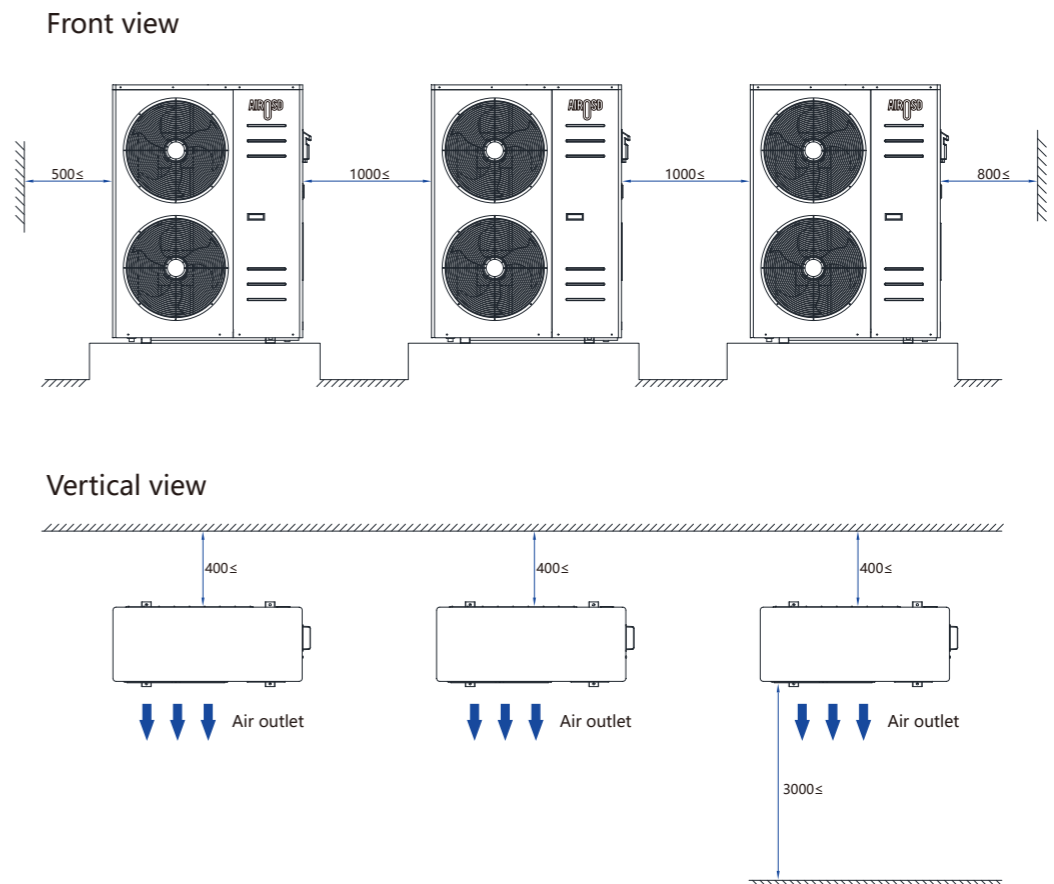

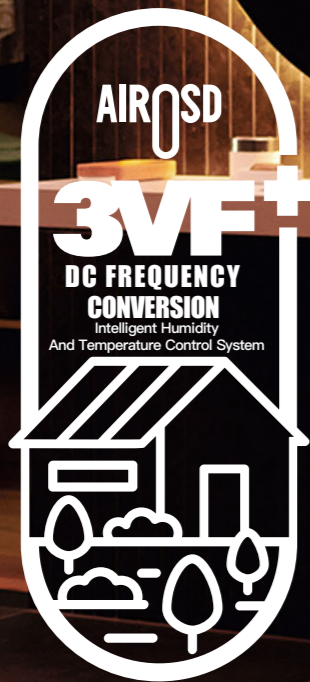

Whole house intelligent control



AIRQSD



AI intelligent control system

**Comfortable temperature**

Most people feel comfortable when the temperature ranges from 18°C to 25 °C in winter, 23°C to 28°C in summer.

**Appropriate humidity**

The most suitable relative humidity is in the range of 40%-60%. The environment with high humidity is harmful to people.

**Higher air quality**

PM2.5, virus, bacteria, formaldehyde, benzene, radon and TVOC gas in indoor air are harmful to human health at anytime.

**Low CO2 level**

People will feel headache, sleepiness and nausea if the indoor CO2 concentration is too high.

Airosd constant temperature, humidity and oxygen intelligent control system

